

HANDBOOK

PC-AD2

2 Stereo Analogue I/O & 2 Stereo AES-3 I/O PCIe
Half Height Sound Card

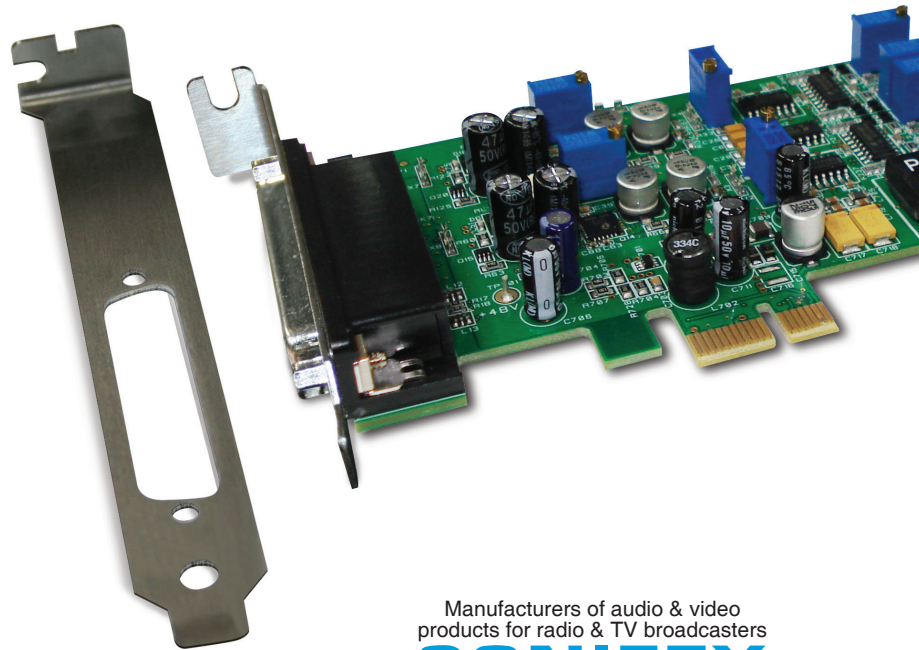

Manufacturers of audio & video
products for radio & TV broadcasters

SONIFEX

For the latest Sonifex handbook information please visit the
Sonifex website at www.sonifex.co.uk

This handbook is for use with the following product:

PC-AD2 2 Stereo Analogue I/O & 2 Stereo AES-3 I/O PCIe Half Height Sound Card

AW10789 Stock Code: 30-333

Revision 1.05, September 2019

©Sonifex Ltd, 2019

All Rights Reserved

Sonifex Ltd, 61, Station Road, Irthlingborough,
Northants, NN9 5QE, England.

Tel: +44 (0)1933 650 700

Fax: +44 (0)1933 650 726

Email: sales@sonifex.co.uk

Website: <http://www.sonifex.co.uk>

Information in this document is subject to change without notice and does not represent a commitment on the part of the vendor. Sonifex Ltd shall not be liable for any loss or damage whatsoever arising from the use of information or any error contained in this manual.

No part of this manual may be reproduced or transmitted in any form or by any means, electronic or mechanical, including photocopying, recording, information storage and retrieval systems, for any purpose other than the purchaser's personal use, without the express written permission of Sonifex Ltd. Unless otherwise noted, all names of companies, products and persons contained herein are part of a completely fictitious adaptation and are designed solely to document the use of Sonifex product.

Made in the UK by **SONIFEX**

Contents

Product Warranty - 2 Year Extended	i
Sonifex Warranty & Liability Terms & Conditions	i
1. Definitions	i
2. Warranty	i
Unpacking Your Product	ii
Repairs & Returns	iii
☞ Conformity	iii
Safety & Installation of Mains Operated Equipment	iii
Voltage Setting Checks	iii
Fuse Rating	iii
Power Cable & Connection	iii
WEEE Directive	iv
Atmosphere/Environment	iv
1. PC-AD2 2 Stereo Analogue I/O & 2 Stereo AES-3 I/O	1
PCle Half Height Sound Card	1
Introduction	1
2. Installation	4
Configuration	4
3. Windows Audio Operation	6
Audio Endpoints	6
Mixer API	6
Audio Engine	6
Windows Mono Recording Bug	7
Playback Endpoints	7
Recording Endpoints	8
Line Input 1 / Microphone Operation	9
4. GPIO	11
5. Technical Specification For PC-AD2	12
PC-AD2 44 Pin Socket:	12
PC-AD2BC XLR Connectors:	12
PC-AD2BC Remote Connectors (9 pin D type plug):	12

Figures

Fig 1-1: PC-AD2 With Small Bracket And Optional large Bracket	1
Fig 2-1: Device Manager Screen	4
Fig 2-2: PC-AD2 Properties/Configuration Screen	5
Fig 3-1: PC-AD2 Line Output 1 Properties/Advanced Screen	7
Fig 3-2: PC-AD2 Line Output 1 Properties/Levels Screen	8
Fig 3-3: PC-AD2 AES 3 Input 1 Properties/Levels Screen	8
Fig 3-4: PC-AD2 AES 3 Frequency Screen	9
Fig 3-5: PC-AD2 Recording Screen	9
Fig 3-6: PC-AD2 Microphone Properties/Custom Screen	10
Fig 4-1: PC-AD2 GPIO Demonstration Screen	11
Fig 4-2: GPIO Connection Example With Relays	12

SONIFEX

Register Online for an Extended 2 Year Warranty

As standard, Sonifex products are supplied with a 1 year back to base warranty.

If you register the product online, you can increase your product warranty to 2 years and we can also keep you informed of any product design improvements or modifications.

Product: _____

Serial No: _____

To register your product, please go online to www.sonifex.co.uk/register

Product Warranty - 2 Year Extended

As standard, Sonifex products are supplied with a 1 year back to base warranty. In order to register the date of purchase and so that we can keep you informed of any product design improvements or modifications, it is important to complete the warranty registration online. Additionally, if you register the product on the Sonifex website, you can increase your product warranty to 2 years. Go to the Sonifex website at: <http://www.sonifex.co.uk/technical/register/index.asp> to apply for your 2 year warranty.

Note: For your own records the product serial number is recorded on the CE certification page of this handbook.

Sonifex Warranty & Liability Terms & Conditions

1. Definitions

‘the Company’ means Sonifex Ltd and where relevant includes companies within the same group of companies as Sonifex Limited.

‘the Goods’ means the goods or any part thereof supplied by the Company and where relevant includes: work carried out by the Company on items supplied by the Purchaser; services supplied by the Company; and software supplied by the Company.

‘the Purchaser’ means the person or organisation who buys or has agreed to buy the Goods.

‘the Price’ means the Price of the Goods and any other charges incurred by the Company in the supply of the Goods.

‘the Warranty Term’ is the length of the product warranty which is usually 12 months from the date of despatch; except when the product has been registered at the Sonifex website when the Warranty Term is 24 months from the date of despatch.

‘the Contract’ means the quotation, these Conditions of Sale and any other document incorporated in a contract between the Company and the Purchaser.

This is the entire Contract between the parties relating to the subject matter hereof and may not be changed or terminated except in writing in accordance with the provisions of this Contract. A reference to the consent, acknowledgement, authority or agreement of the Company means in writing and only by a director of the Company.

2. Warranty

- a. The Company agrees to repair or (at its discretion) replace Goods which are found to be defective (fair wear and tear excepted) and which are returned to the Company within the Warranty Term provided that each of the following are satisfied:
 - i. notification of any defect is given to the Company immediately upon its becoming apparent to the Purchaser;
 - ii. the Goods have only been operated under normal operating conditions and have only been subject to normal use (and in particular the Goods must have been correctly connected and must not have been subject to high voltage or to ionising radiation and must not have been used contrary to the Company’s technical recommendations);
 - iii. the Goods are returned to the Company’s premises at the Purchaser’s expense;
 - iv. any Goods or parts of Goods replaced shall become the property of the Company;
 - v. no work whatsoever (other than normal and proper maintenance) has been carried out to the Goods or any part of the Goods without the Company’s prior written consent;

- vi. the defect has not arisen from a design made, furnished or specified by the Purchaser;
 - vii. the Goods have been assembled or incorporated into other goods only in accordance with any instructions issued by the Company;
 - viii. the defect has not arisen from a design modified by the Purchaser;
 - ix. the defect has not arisen from an item manufactured by a person other than the Company. In respect of any item manufactured by a person other than the Company, the Purchaser shall only be entitled to the benefit of any warranty or guarantee provided by such manufacturer to the Company.
- b. In respect of computer software supplied by the Company the Company does not warrant that the use of the software will be uninterrupted or error free.
- c. The Company accepts liability:
- (i) for death or personal injury to the extent that it results from the negligence of the Company, its employees (whilst in the course of their employment) or its agents (in the course of the agency);
 - (ii) for any breach by the Company of any statutory undertaking as to title, quiet possession and freedom from encumbrance.
- d. Subject to conditions (a) and (c) from the time of despatch of the Goods from the Company's premises the Purchaser shall be responsible for any defect in the Goods or loss, damage, nuisance or interference whatsoever consequential economic or otherwise or wastage of material resulting from or caused by or to the Goods. In particular the Company shall not be liable for any loss of profits or other economic losses. The Company accordingly excludes all liability for the same.
- e. At the request and expense of the Purchaser the Company will test the Goods to ascertain performance levels and provide a report of the results of that test. The report will be accurate at the time of the test, to the best of the belief and knowledge of the Company, and the Company accepts no liability in respect of its accuracy beyond that set out in Condition (a).
- f. Subject to Condition (e) no representation, condition, warranty or other term, express or implied (by statute or otherwise) is given by the Company that the Goods are of any particular quality or standard or will enable the Purchaser to attain any particular performance or result, or will be suitable for any particular purpose or use under specific conditions or will provide any particular capacity, notwithstanding that the requirement for such performance, result or capacity or that such particular purpose or conditions may have been known (or ought to have been known) to the Company, its employees or agents.
- g. (i) To the extent that the Company is held legally liable to the Purchaser for any single breach of contract, tort, representation or other act or default, the Company's liability for the same shall not exceed the price of the Goods.
- (ii) The restriction of liability in Condition (g)(i) shall not apply to any liability accepted by the Seller in Condition (c).
- h. Where the Goods are sold under a consumer transaction (as defined by the Consumer Transactions (Restrictions on Statements) Order 1976) the statutory rights of the Purchaser are not affected by these Conditions of Sale.

Unpacking Your Product

Each product is shipped in protective packaging and should be inspected for damage before use. If there is any transit damage take pictures of the product packaging and notify the carrier immediately with all the relevant

details of the shipment. Packing materials should be kept for inspection and also for if the product needs to be returned.

The product is shipped with the following equipment so please check to ensure that you have all of the items below. If anything is missing, please contact the supplier of your equipment immediately.

Item	Quantity
Product unit	1
Handbook	1
Driver CD	1

If you require a different power lead, please let us know when ordering the product.

Repairs & Returns

Please contact Sonifex or your supplier if you have any problems with your Sonifex product. Email technical.support@sonifex.co.uk for the repair/upgrade/returns procedure, or for support & questions regarding the product operation.

CE Conformity

The products in this manual comply with the essential requirements of the relevant European health, safety and environmental protection legislation.

The technical justification file for this product is available at Sonifex Ltd.

The declaration of conformity can be found at:
<http://www.sonifex.co.uk/declarations>

Safety & Installation of Mains Operated Equipment

There are no user serviceable parts inside the equipment. If you should ever need to look inside the unit, always disconnect the mains supply before removing the equipment covers. The cover is connected to earth by means of the fixing screws. It is essential to maintain this earth/ground connection to ensure a safe operating environment and provide electromagnetic shielding.

Voltage Setting Checks

Ensure that the machine operating voltage is correct for your mains power supply by checking the box in which your product was supplied. The voltage is shown on the box label. The available voltage settings are 115V, or 230V. Please note that all products are either switchable between 115V and 230V, or have a universal power supply.

Fuse Rating





The product is supplied with a single fuse in the live conducting path of the mains power input. For reasons of safety it is important that the correct rating and type of fuse is used. Incorrectly rated fuses could present a possible fire hazard, under equipment fault conditions. The active fuse is fitted on the outside rear panel of the unit.

Power Cable & Connection

An IEC power connector is supplied with the product which has a moulded plug attached.

The mains plug or IEC power connector is used as the disconnect device. The mains plug and IEC power connector shall remain readily operable to disconnect the apparatus in case of a fault or emergency.

The mains lead is automatically configured for the country that the product is being sent to, from one of:

Territory	Voltage	IEC Lead Type	Image
UK & Middle East	230V	UK 3 pin to IEC lead	
Europe	230V	European Schuko round 2 pin to IEC lead	
USA, Canada and South America	115V	3 flat pin to IEC lead	
Australia & New Zealand	230V	Australasian 3 flat pin to IEC lead	

Connect the equipment in accordance with the connection details and before applying power to the unit, check that the machine has the correct operating voltage for your mains power supply.

This apparatus is of a class I construction. It must be connected to a mains socket outlet with a protective earthing connection.

Important note: If there is an earth/ground terminal on the rear panel of the product then it must be connected to Earth.

WEEE Directive



The Waste Electrical and Electronic Equipment (WEEE) Directive was agreed on 13 February 2003, along with the related Directive 2002/95/EC on Restrictions of the use of certain Hazardous Substances in electrical and electronic equipment (RoHS). The Waste Electrical and Electronic Equipment Directive (WEEE) aims to minimise the impacts of electrical and electronic equipment on the environment during their life times and when they become waste. All products manufactured by Sonifex Ltd have the WEEE directive label placed on the case. Sonifex Ltd will be happy to give you information about local organisations that can reprocess the product when it reaches its “end of use”, or alternatively all products that have reached “end of use” can be returned to Sonifex and will be reprocessed correctly free of charge.

Atmosphere/Environment

This apparatus should be installed in an area that is not subject to excessive temperature variation (<0°C, >50°C), moisture, dust or vibration.

This apparatus shall not be exposed to dripping or splashing, and no objects filled with water, such as vases shall be placed on the apparatus.

1. PC-AD2 2 Stereo Analogue I/O & 2 Stereo AES-3 I/O PCIe Half Height Sound Card

Introduction

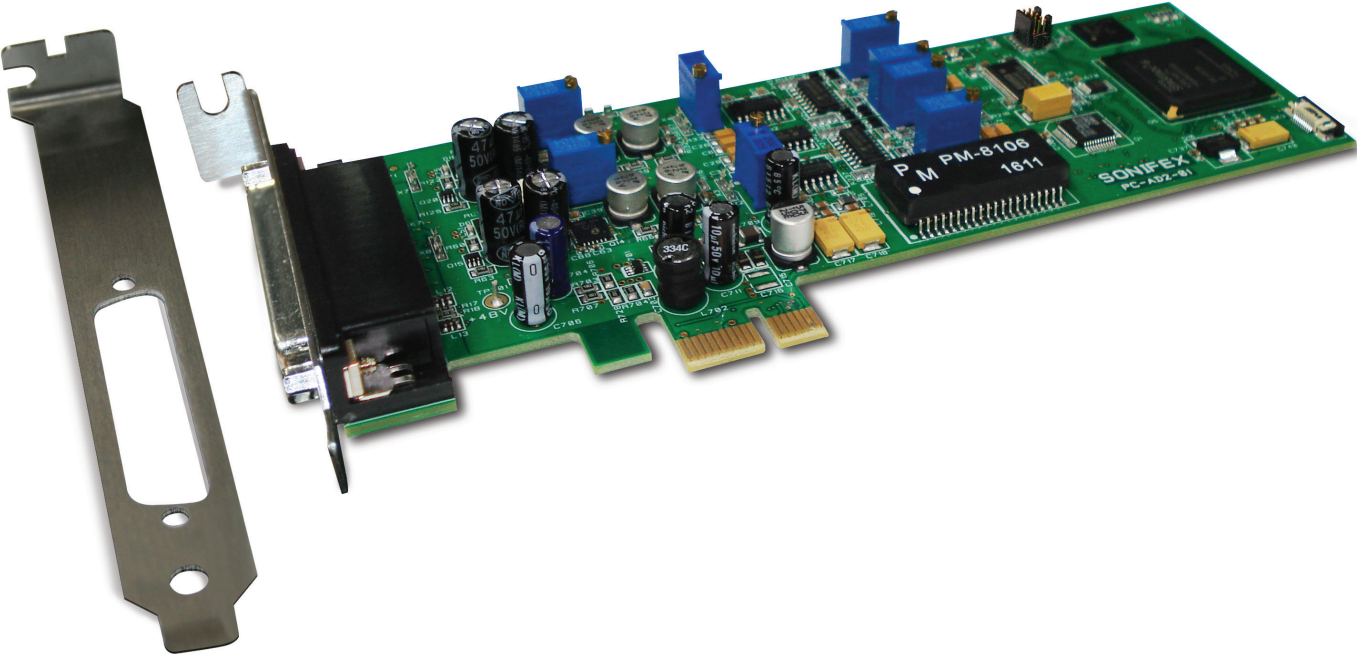

Fig 1-1: PC-AD2 With Small Bracket And Optional large Bracket

Category: Professional Sound Cards & Radio Capture Cards.

Product Function: Provides two AES-3 and two balanced analogue audio inputs and outputs for use in a PC.

Typical Applications: Audio workstations, recording studios, automation systems, audio logging, multi-channel playback.

Features:

- 2 independent transformer-coupled AES-3 inputs and outputs.
- 2 independent high level balanced stereo inputs and outputs.
- Line input 1 can also act as a stereo mic, or dual mono mic input, with +48V phantom power and limiter.
- 1 AES-11 synchronisation input.
- 2 opto isolated GPIOs.
- 24-bit audio resolution.
- Sampling rates up to 192kHz.
- Asynchronous sampling rate converters on each input.
- Card synchronisation to any input, AES-11 input or other PC-AD2 card.
- 32 and 64 bit drivers for Windows 7/8/10, Windows Server 2008/R2, 2012/R2.
- WDM-compliant supporting Wave, DirectSound, DirectShow and Core Audio APIs.
- Simultaneous record/play per channel.

The PC-AD2 is a dual stereo analogue input/output and dual stereo AES-3 digital input/output sound card in the PCIe half height format. One of the analogue inputs can be used as a mic input, there is a dedicated AES-11 sync input and also 2 GPIOs. It is fully compatible with the Windows™ Wave, DirectSound, DirectShow, MCI and Core Audio APIs, supporting audio up to 24 bit, 192kHz.

The PC-AD2 is a professional-quality half-height PCIe audio input-output card, offering both analogue and AES-3 stereo inputs and outputs. It is supplied with a Windows WDM driver to provide full sound card functionality on Windows 7, 8, 8.1, 10 and Windows Server 2008 R2, 2012 and 2012 R2. Many of the modern smaller PC systems only have space for half height PCIe cards – the PC-AD2 card has been designed with this in mind allowing a high channel count in a small format card.

The PC-AD2 has two stereo analogue inputs (the first of which can be used as a stereo mic, or dual mono mic input) and two stereo analogue outputs, two stereo AES-3 inputs and two stereo outputs, a dedicated AES-11 sync input and two general purpose (GPIO) inputs and outputs.

When acting as a microphone input, phantom power can be applied at +48V to the microphone input connection, but is removed if Line Input 1 becomes active. An audio limiter on the mic input automatically reduces the microphone gain if the recording level approaches clipping.

The peak analogue level sets the clipping threshold for the analogue inputs to one of +15, +18, +20, +22 or +24dBu. With the Windows endpoint faders set to maximum, these levels correspond to full scale on the software audio streams.

The card's core sampling rate can be synchronised to an external source chosen from either of the AES-3 inputs, the dedicated AES-11 sync input or by using the inter-card cable (PC-AD2SY) for synchronising to another PC-AD2.

Independent asynchronous sampling rate conversion on the inputs supports rates from 32kHz to 192kHz, while the output rate can be configured as 192kHz, 96kHz, 88.2kHz, 48kHz, 44.1kHz or 32kHz, either free-running or locked to an AES11 reference on any of the digital inputs. Software sampling rate conversion is automatically inserted by Windows when the application rate does not match the hardware rate, ensuring that files of

any sample rate can be played and recorded. Extended software bit depths of 32 and 24 bits are supported as well as 16 and 8 bits for playback and recording. For each AES-3 input, the received sampling rate, frame lock and sampling rate converter status is shown.

The playback and recording topology is virtualised because Windows treats each input source as its own 'endpoint'. Endpoints are the physical audio sources and destinations, such as microphones, speakers and line connectors. Each of the PC-AD2 card's physical line inputs is represented by an endpoint device, and as the hardware has separate A/D converters or AES-3 receivers for each one, they can be used simultaneously. A Microphone endpoint is also created which is shared with analogue Line Input 1 endpoint. The Windows mixer API is virtualised for each application, providing just a mute and volume control for each endpoint and affecting only the audio going to and from that application.

The PC-AD2 has two optically-isolated general purpose inputs and outputs which are accessed through a programming API supplied with the driver package. A demo program is included with the driver package to illustrate the operation of the GPIO API and to quickly test the GPIO functionality.

All the standard Windows audio APIs are available including the Core Audio API, Wave, DirectSound, DirectShow, MCI and MIDI playback, as are a variety of audio compression modes via the Windows Audio Compression Manager or other software compression systems.

Multiple cards may be installed in a single PC.

A 44-pin high-density D-type connector to XLRs & 9 pin D-type breakout lead is offered as an option, the PC-AD2BC.

2. Installation

The software package consists of the driver installation file (PCAD2x86.inf or PCAD2x64.inf), the kernel-mode driver (PCAD2.sys), the configuration DLL (PCAD2Coinstaller32.dll or PCAD2Coinstaller64.dll) and the catalogue file (PCAD2x86.cat or PCAD2x64.cat).

Switch off the computer and carefully install the PC-AD2 card in any free PCIe slot, observing the normal precautions against static electricity discharge. Then switch the computer back on and boot Windows.

On Windows 7, right-click on the **My Computer** icon in the Start menu, select **Properties**, then click on **Device Manager**. On Windows 8 and later, open the **Control Panel**, go to **System and Security** and then **System**, and open **Device Manager** from the link in the left hand pane. The PC-AD2 will be listed under **Other Devices** as a **Multimedia Audio Controller**.

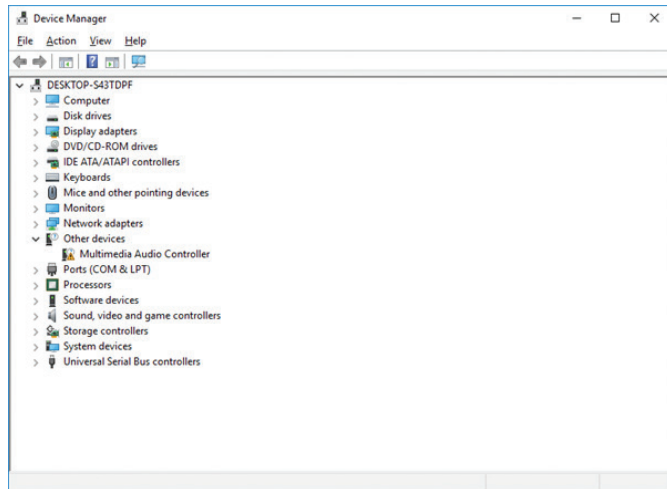

Fig 2-1: Device Manager Screen

Right-click on it, select **Update Driver Software**, then click on **Browse my computer for driver software** and click on the Browse button to navigate to the driver's location. Click on **Next** to install the driver.

At the completion of the installation process the loudspeaker symbol in the toolbar at the bottom of the screen should be enabled. Your PC-AD2 is now ready for use.

Configuration

To change the configuration, open **Device Manager**, expand **Sound, video and game controllers**, then right-click on **PC-AD2**, select **Properties** and click on the **Configuration** tab.

There are four configuration settings for the PC-AD2, these being Core Sampling Rate, Analogue Maximum Level, Analogue Input 1 type, and Sync Source.

The **Core Sampling Rate** sets the analogue converter rates, the AES-3 output rate and the internal rate of the Windows audio engine. Note that the audio engine will automatically apply sampling rate conversion if an application's rate doesn't match its internal rate.

The **Analogue Maximum Level** sets the clipping threshold for the analogue inputs and outputs. With the Windows endpoint faders set to maximum, these levels correspond to full scale on the software audio streams.

The **Analogue Input 1** settings allow the first analogue input to be set as a stereo line source, a stereo microphone or a pair of mono microphones.

The **Sync Source** setting allows the card's core sampling rate to be synchronised to an external source. Options include either of the AES-3 inputs, the dedicated AES-11 sync input or the inter-card cable for synchronising to another PC-AD2. Note that the card's core sampling rate must be the same as the external source for synchronisation to occur.

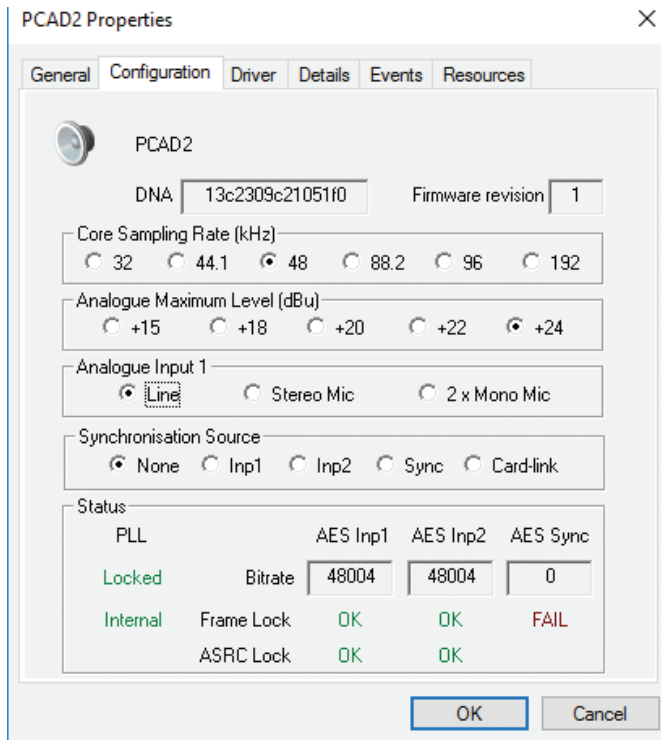

Fig 2-2: PC-AD2 Properties/Configuration Screen

For synchronising to another PC-AD2, connect a coaxial cable from SK1 on the back of the master card to SK2 on the front of the slave card. Multiple cards can be daisy-chained in this fashion, with each synchronised to the preceding one.

At the bottom of the configuration page the PLL and AES input status is shown. The PLL will indicate whether it is **locked** or **unlocked** and whether its source is **internal** or **external**. When a sync source other than **None** is selected, the source indicator will show **external** in green when it's locked to that source, or **internal** in orange if it's unable to do so (typically because the source sampling rate doesn't match the card's core sampling rate).

For each AES-3 input, the received sampling rate, frame lock and sampling rate converter status is shown. If the displayed rate varies erratically or if frame or converter lock can't be achieved, check the cabling and make sure the input isn't doubly-terminated.

3. Windows Audio Operation

The audio subsystem of Windows 7, 8, 10 and corresponding server versions changed substantially from earlier versions of Windows, although most applications should continue to work without modification. The major differences likely to affect users of the PC-AD2 are described below.

Audio Endpoints

Key to the new system is the concept of **audio endpoints**. These are the physical audio sources and destinations, such as microphones, speakers and line connectors.

Previously, an audio capture device would typically have multiple inputs which were combined in a mixer or selector. Now, each input is represented by its own device, and Windows itself operates the card's selector to route the chosen source to the A/D converter.

In the case of the PC-AD2, each of the physical line inputs is represented by an endpoint device, and as the hardware has separate A/D converters or AES-3 receivers for each one, they can be used simultaneously. A

Microphone endpoint is also created which is shared with analogue **Line Input 1**, so only one of these can be active at any given time. When an application opens a shared input endpoint, it is automatically activated and the other shared endpoint is made unavailable.

Windows has a default playback endpoint and a default recording endpoint, which are typically used by applications where the input or output device cannot be explicitly chosen. To change the default endpoints, right-click on the loudspeaker symbol, selecting **Playback devices** or **Recording devices**, then right-click on the desired endpoint and select **Set as Default Device**. The default device is remembered across reboots and should not need to be set again. A default communications device can also be set for use by telephony applications.

Mixer API

The legacy Windows mixer API is virtualised for each application, providing just a mute and volume control for each endpoint and affecting only the audio going to and from that application. The hardware controls on the card itself are not accessible from the mixer API.

New applications can use the Core Audio APIs to directly access the hardware mixer controls and peak meter nodes through the DeviceTopology API and the EndpointVolume API (which includes the IAudioEndpointVolume and IAudioMeterInformation interfaces). These are documented in the Windows SDK available from Microsoft, however note that these APIs don't work with versions of Windows earlier than Vista.

Audio Engine

The Windows audio engine runs at a fixed sampling rate and bit depth. The PC-AD2 driver sets the sampling rate to the card's core rate and the bit depth to 24-bit for all the inputs and outputs. The Windows sampling rate converter is used whenever a different sampling rate or bit depth is requested by applications. The engine bit depth for each endpoint can be changed to 16-bit if required by selecting the endpoint, clicking on **Properties**, and then clicking on the **Advanced** tab.

If your applications will be playing or recording at rates higher than 48kHz, you will need to set the card's core rate accordingly otherwise Windows will down-sample to 48kHz.

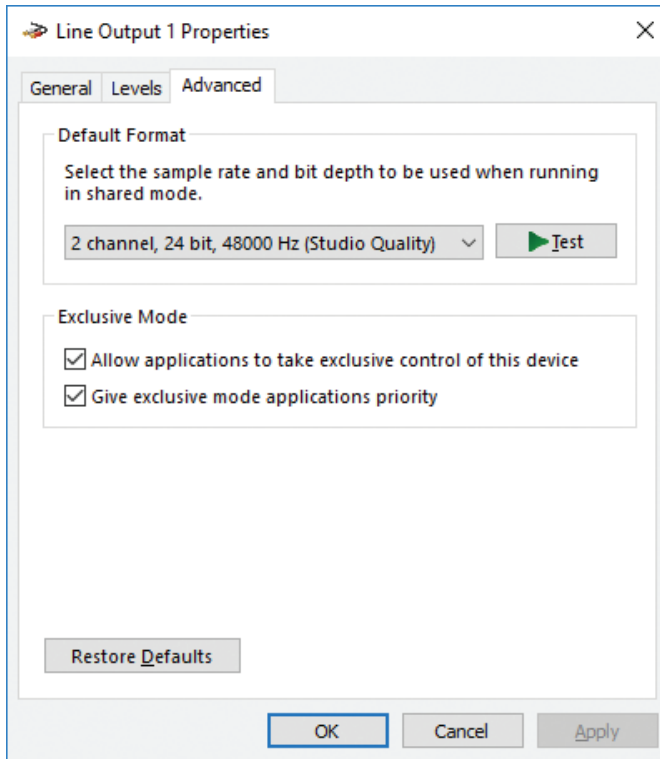

Fig 3-1: PC-AD2 Line Output 1 Properties/Advanced Screen

Windows Mono Recording Bug

Windows currently has a bug which causes mono recording streams to capture only the left channel of the source, rather than mixing the left and right as earlier versions did. As a workaround until this is fixed, the driver provides a **Mono Mix** recording endpoint for each of the card's inputs. By

default these are disabled, but can be individually enabled as follows.

Right-click on the loudspeaker symbol in the bottom right hand corner of the screen and select Recording Devices. Right-click on any of the sources and check Show Disabled Devices, which should then reveal two additional sources called Input 1 Mono Mix and Input 2 Mono Mix. To enable these, right-click on them and select Enable. Note that, after enabling, it will still show as currently unavailable as these endpoints are multiplexed with the normal stereo inputs and are only activated when opened by a recording application. Also be aware that, for the same reason, the stereo and mono mix endpoints for the same source can't be used simultaneously.

The Mono Mix endpoints should be used for communications applications such as Skype which open a mono capture stream.

Note that there are no Mono Mix endpoints associated with the mono microphone inputs when that mode is selected as these are inherently mono.

Playback Endpoints

Each of the analogue and AES-3 playback endpoints has a set of control faders which are accessed by right-clicking on the endpoint, selecting **Properties** and clicking on the **Levels** tab.

At the top is the master fader which sets the overall output level. Below this are individual faders for each of the playback mixer sources.

The Wave source is the output from any playback software running on the PC. By default it is set to 100%. If multiple applications are producing audio, Windows automatically mixes their output, with sampling rate and bit depth conversion applied when necessary, before applying the end result to the card.

Below this are faders corresponding to the card's inputs. Each input can be passed directly to the output by opening the corresponding fader.

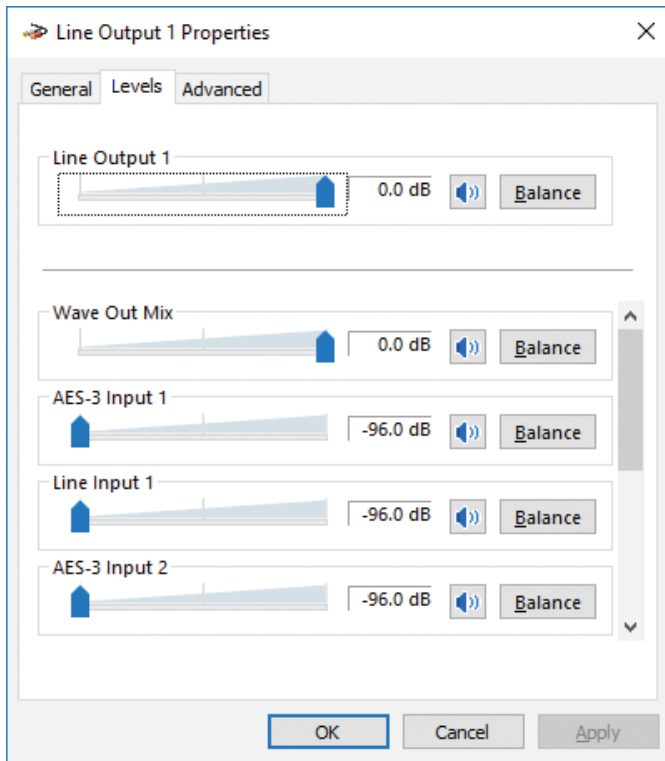

Fig 3-2: PC-AD2 Line Output 1 Properties/Levels Screen

Recording Endpoints

Each of the analogue and AES-3 recording endpoints has a fader and mute control which are accessed by right-clicking on the endpoint, selecting **Properties** and clicking on the **Levels** tab.

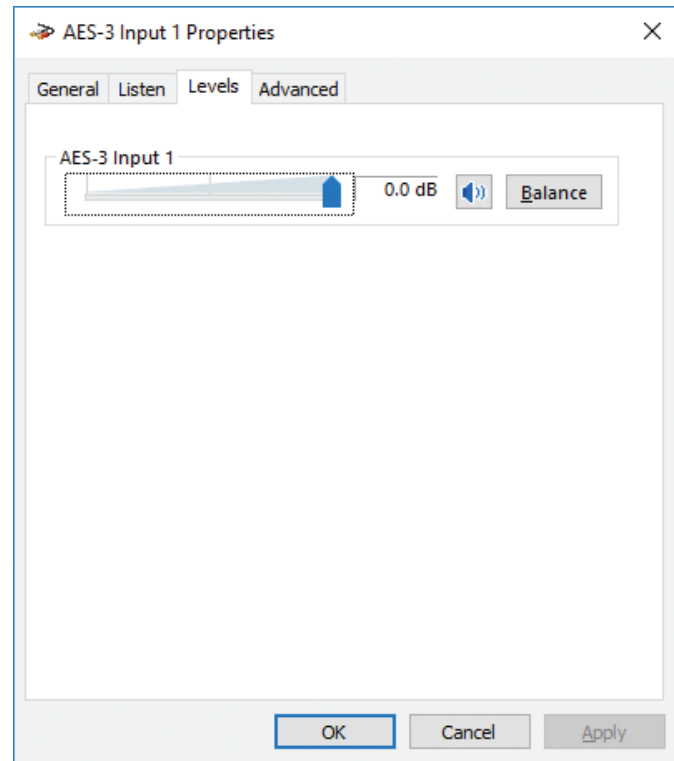

Fig 3-3: PC-AD2 AES 3 Input 1 Properties/Levels Screen

The **Listen** option allows the input's audio to be routed by Windows to any audio output **device** on the PC. The **listen** settings are preserved across reboots and take effect even if no user is logged in.

The AES-3 inputs have asynchronous sampling rate converters that convert the received streams to the card's core sampling rate and take care of any

sample timing differences. All aliasing products are attenuated by more than 120dB. The converter's passband frequency response is shown below, normalised to the lower of the input and core sampling rates. The vertical scale is 10dB per division.

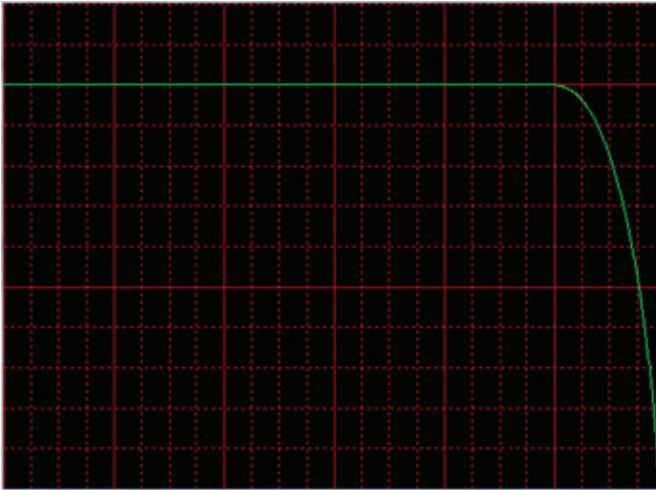

Fig 3-4: PC-AD2 AES 3 Frequency Screen

Line Input 1 / Microphone Operation

The first analogue input channel on the PC-AD2 can be used either as a line level, stereo microphone or dual mono microphone input. The recording endpoints will change according to the mode selected. (see the earlier section for an explanation of audio endpoints).

A shared endpoint is automatically activated when an application starts recording from it, with the other endpoint made unavailable. The PC-AD2 uses this mechanism to switch the microphone preamplifier and optional +48V phantom power on and off.

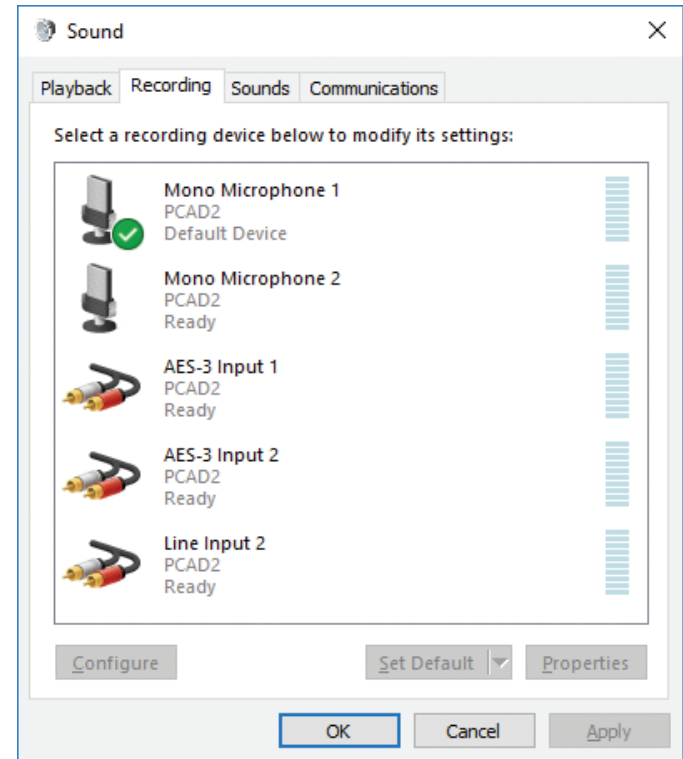

Fig 3-5: PC-AD2 Recording Screen

If only one or the other is ever going to be used, it's recommended that the unused endpoint be disabled so that the required one is always available. To disable an endpoint, open the Sound applet by right-clicking on the loudspeaker symbol in the bottom right hand corner of the screen and selecting **Recording devices**. Right-click on the endpoint in question and select **Disable**.

To adjust the sensitivity of the microphone input, right-click on the endpoint, select **Properties** and click on the **Levels** tab. The default setting is -20dB but can be adjusted from 0dB to -60dB. Note that the setting display can be switched between percentage and decibels by right-clicking on it and selecting the desired option.

Each microphone endpoint has two additional settings for phantom power and an audio limiter. To access these, right-click on the endpoint, select **Properties** then click on the **Custom** tab.

Phantom power, when selected, applies +48V to the microphone input connections. When the stereo microphone mode is selected, phantom power is applied to both the left and right inputs, while in dual mono microphone mode, the phantom power on each input is independently settable.

The audio limiter automatically reduces the microphone gain if the recording level approaches clipping. Because of the twelve sample delay through the A/D converter, the limiter can't entirely prevent clipping but will minimise its effects. In stereo microphone mode, the limiter will jointly act on both channels when either exceeds its threshold, while in mono microphone mode, the limiters on each channel are fully independent.

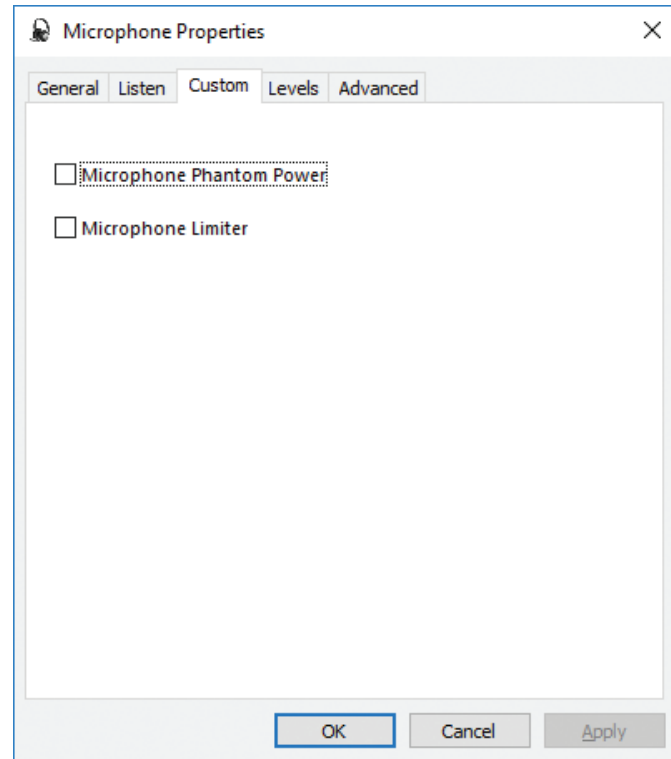

Fig 3-6: PC-AD2 Microphone Properties/Custom Screen

4. GPIO

The PC-AD2 has two optically-isolated general purpose inputs and outputs which are accessed through a programming API supplied with the driver package.

The API library itself is in the PCAD2.dll file. To access this from your application software, insert the header file PCAD2.h into your source and link to the library file PCAD2.lib. 32-bit and 64-bit versions of these files are provided.

The API consists of four functions as follows.

HANDLE **PCAD2Open** (unsigned *CardInstance*);

This returns a handle to the card for use with the other API functions. When no longer required, this handle must be closed by calling the Windows function **CloseHandle**.

When multiple cards are in use, *CardInstance* selects the card. If only one card is present, set this to zero.

unsigned **PCAD2GetGPI** (HANDLE *CardHandle*);

This returns the state of the two general purpose inputs in the least significant bits. Set *CardHandle* to the handle returned from **PCAD2Open**.

void **PCAD2SetGPO** (HANDLE *CardHandle*, unsigned *Outputs*);

This sets the state of the two general purpose outputs from the least significant bits of *Outputs*. Set *CardHandle* to the handle returned from **PCAD2Open**.

__int64 **PCAD2GetHardwareID** (HANDLE *CardHandle*);

This returns the unique 64-bit hardware identifier for the card. It can be used to disambiguate multiple cards. The same identifier is shown on the card's Configuration page in Device Manager.

A simple demonstration program is included with the driver package to illustrate the operation of the GPIO API and to quickly test the GPIO functionality.

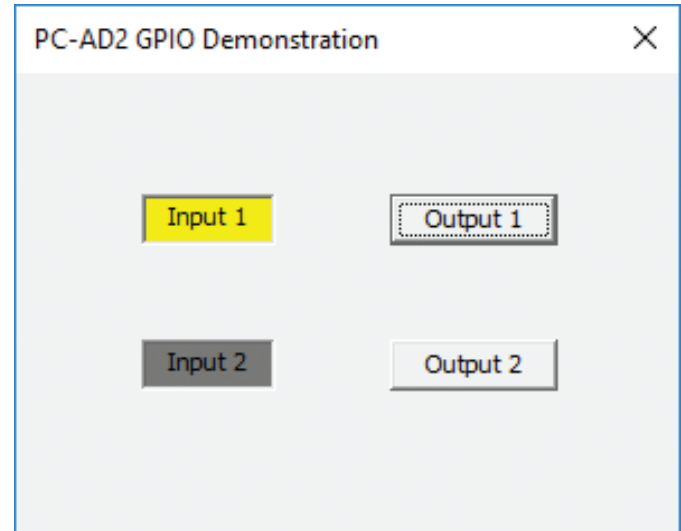

Fig 4-1: PC-AD2 GPIO Demonstration Screen

The input indicators will glow yellow when the corresponding inputs are active, while holding down the left mouse button on the output buttons will activate the corresponding outputs.

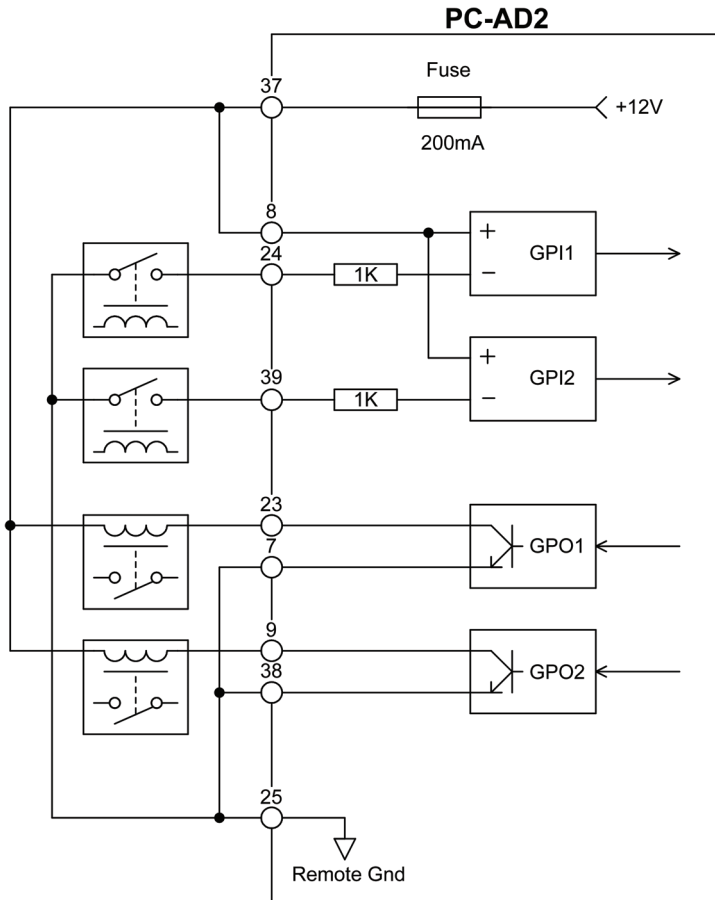

Fig 4-2: GPIO Connection Example With Relays

5. Technical Specification For PC-AD2

PC-AD2 44 Pin Socket:

Pin 1	Mic/Line In 1 Left Non Phase	Pin 12	Line Out 2 Right Non Phase	Pin 23	Remote Out 1 Collector	Pin 34	Digital In 1 Non Phase
Pin 2	Mic/Line In 1 Right Phase	Pin 13	Line Out 2 Left Non Phase	Pin 24	Remote in 1 Cathode	Pin 35	Digital In 2 Phase
Pin 3	Line In 2 Left Phase	Pin 14	Line Out 1 Right Phase	Pin 25	Remote Ground	Pin 36	Digital Sync In Phase
Pin 4	Digital In 1 Ground	Pin 15	Line Out 1 Left Phase	Pin 26	Digital Out 2 Ground	Pin 37	Remote VCC Out (+12V DC)
Pin 5	Digital In 2 Non Phase	Pin 16	Mic/Line In 1 Ground	Pin 27	Digital Out 1 Ground	Pin 38	Remote Out 2 Emitter
Pin 6	Digital Sync In Non Phase	Pin 17	Mic/Line In 1 Right Non Phase	Pin 28	Line Out 2 Ground	Pin 39	Remote in 2 Cathode
Pin 7	Remote Out 1 Emitter	Pin 18	Line In 2 Left Non Phase	Pin 29	Line Out 1 Right Non Phase	Pin 40	Digital Out 2 Phase
Pin 8	Remote in Common Anode	Pin 19	Line In 2 Right Phase	Pin 30	Line Out 1 Left Non Phase	Pin 41	Digital Out 1 Phase
Pin 9	Remote Out 2 Collector	Pin 20	Digital In 1 Phase	Pin 31	Mic/Line In 1 Left Phase	Pin 42	Line Out 2 Right Phase
Pin 10	Digital Out 2 Non Phase	Pin 21	Digital In 2 Ground	Pin 32	Line In 2 Ground	Pin 43	Line Out 2 Left Phase
Pin 11	Digital Out 1 Non Phase	Pin 22	Digital Sync In Ground	Pin 33	Line In 2 Right Non Phase	Pin 44	Line Out 1 Ground

PC-AD2BC XLR Connectors:

Pin 1	Ground
Pin 2	Phase
Pin 3	Non Phase

PC-AD2BC Remote Connectors (9 pin D type plug):

Pin 1	Remote Out 1 Emitter
Pin 2	Remote Out 1 Collector
Pin 3	Remote Out 2 Emitter
Pin 4	Remote Out 2 Collector
Pin 5	Remote Ground
Pin 6	Remote VCC Out (+12V DC)
Pin 7	Remote In Common
Pin 8	Remote In 1
Pin 9	Remote In 2

5 PC-AD2 - Technical Specification

Operating Systems Supported

Platform:	Windows 7, 8, 8.1 and 10 (32-bit and 64-bit versions) Server 2008 R2, 2012 and 2012 R2.
-----------	--

PCIe Specification

Card Interface:	Single lane PCIe 1.1
-----------------	----------------------

Audio Specification

Analogue Sampling Rate:	32kHz, 44.1kHz, 48kHz, 88.2kHz, 96kHz or 192kHz
Analogue Resolution:	24 bits
Dynamic Range:	>100dB typical (unweighted)
Analogue THD+N:	< 0.0015% (-96dB)
Analogue Input Interface:	2 x stereo balanced analogue line (1 can be switched to microphone)
Analogue Input Impedance:	20k Ω (balanced line), 2.5k Ω (microphone)
Analogue Output Impedance:	120 Ω (balanced)
Analogue Maximum Signal:	+15dBu, +18dBu, +20dBu, +22dBu, +24 dBu (software settable)
Microphone Sensitivity:	-58dBu to +2dBu for full scale input
Microphone E.I.N.:	-128dBu A weighted (Sample rate 48kHz, max gain, 200 Ω source)
Microphone CMRR:	77dB @ 1kHz, 77dB @ 10kHz
Microphone Phantom Power:	+48V (software enabled)
Frequency Response:	Input – 1Hz to 88kHz Output – 1Hz to 88kHz (192kHz hardware sampling rate)
Digital Audio Interface:	2 x AES-3 (formerly known as AES/EBU) inputs/outputs
Digital Input Impedance:	110 Ω transformer coupled
Synchronisation Input:	1 x AES-11 input synchronisation:
Output Sampling Rates:	32kHz, 44.1kHz, 48kHz, 88.2kHz, 96kHz and 192kHz

Input Sampling Rates:	32kHz to 192kHz
Software Sampling Rates:	Any rate from 10Hz to 384kHz
Software Resolution:	32, 24, 16 or 8 bits
GPIO Inputs:	Optically isolated, 2.5 to 50V on (2.5 to 50mA).
GPIO Outputs:	Optically isolated, 5mA max on, 80V max off.
Connector:	44-pin high-density D-type female

Equipment Type

PC-AD2	2 Stereo analogue I/O & 2 stereo AES-3 I/O PCIe half height sound card
--------	---

Physical Specification

Dimensions (Raw):	18cm (L) x 7.0cm (H) x 2cm (D) 7.1" (L) x 2.8" (H) x 0.8" (D)
Dimensions (Boxed):	27cm (L) x 22.5cm (H) x 6cm (D) 10.6" (L) x 8.9" (H) x 2.4" (D)
Weight:	Nett: 0.10kg Gross: 0.20kg Nett: 0.2lbs Gross: 0.4lbs

Accessories

PC-AD2BC	PC-AD2 full XLR & 9 pin D-type breakout cable
PC-AD2SY	Cable to sync 2 x PC-AD2 cards

SONIFEX

www.sonifex.co.uk

t:+44 (0)1933 650 700

f:+44 (0)1933 650 726

sales@sonifex.co.uk